

TOP-V8/4

Control unit with dimmer function for single colour LEDs with voltage, 12-36 VDC, 4 outputs, Max 8 A per output.
RX radio 433.92 MHz, 3 wired inputs, input for extender.

NEXTA
T E C H



INDEX

1 - PRODUCT FEATURES

- 1.1 - TECHNICAL DATA
- 1.2 - DESCRIPTION

2 - ELECTRICAL CONNECTION

- 2.1 - CONNECTION DIAGRAM
- 2.2 - DESCRIPTION OF CONNECTIONS

3 - USE OF THE CONTROL UNIT

- 3.1 - USE VIA RADIO
- 3.2 - USE VIA WIRE

4 - CONTROL UNIT SETTINGS

- 4.0 - SELECTION OF TYPE OF LOAD CONNECTED
- 4.1 - RADIO PROGRAMMING OF MULTIFUNCTIONAL AND GENERIC TRANSMITTERS
- 4.2 - DELETION OF RADIO
- 4.3 - "SAVE" FUNCTION (BRIGHTNESS LEVEL AND COLOUR AT SWITCH-ON)
- 4.4 - FADE SETTING: GRADUAL SWITCH-ON
- 4.5 - FADE SETTING: GRADUAL SWITCH-OFF
- 4.6 - SELECTION OF MINIMUM INTENSITY VALUE
- 4.7 - CHOICE OF LOADS MATCHED WITH WIRED CONTROLS
- 4.8 - LOAD STATE WHEN THE CONTROL UNIT IS SWITCHED ON
- 4.9 - TIMED ON
- 4.10 - FACTORY SETTINGS, RESET CONTROL UNIT

5 - FURTHER DETAILS

- 5.1 - "SOFT OFF 1 HR" FUNCTION: FADE OFF

1 - PRODUCT FEATURES

1.1 TECHNICAL DATA

Power supply	12-36 Vdc
Output	Max load 8 A: 90 W (with 12 VDC) per output 180 W (with 24 VDC) per output 270 W (with 36 VDC) per output.
Type of load	Single colour LED with constant voltage
N° of programmable transmitters	30
Radio frequency	433.920mhz ISM
Protection rating	IP20
Operating temperature	-20 +55 °C
Dimensions	174x46x35 mm

Picture 1.1a

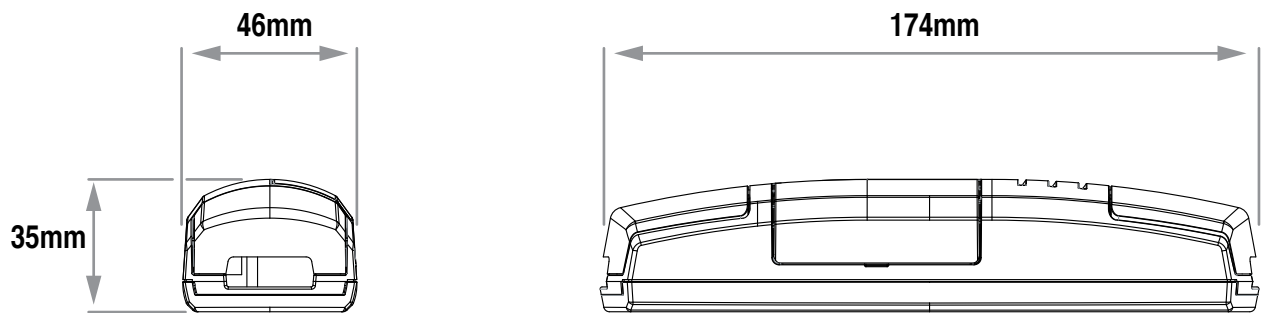

Picture 1.1b

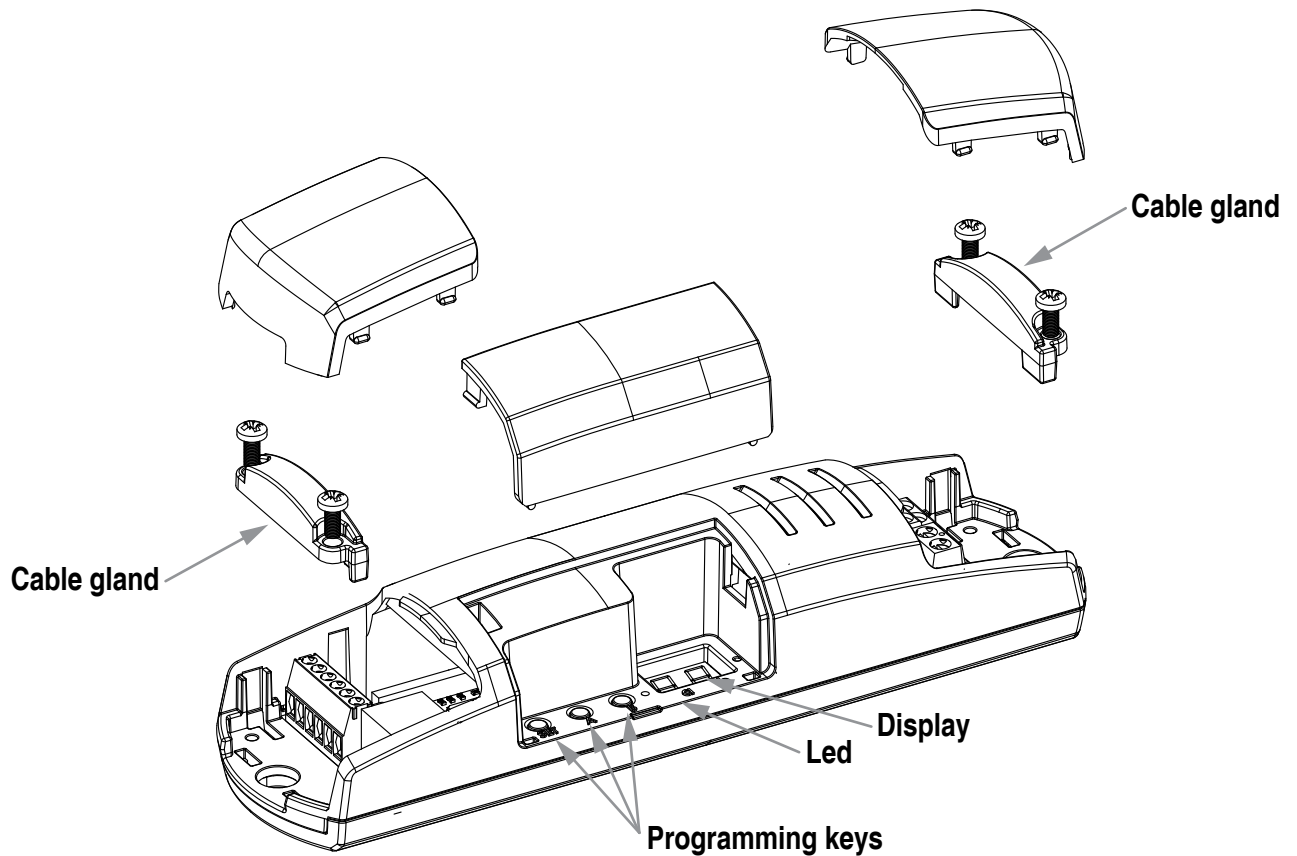

1.2 DESCRIPTION

TOP-V8/4 is an electronic control unit with Dimmer function for wireless and wired control of LEDs with constant voltage. The 4 synchronisable outputs, each with maximum consumption of 8 A and the option of connecting up to 4 further extenders, enable synchronised control of high powers. Wired inputs with button.

Wide-ranging and accurate dimmer function; fade on and off that can be set to between 0 and 10 seconds.

The ISM (industrial, scientific and medical) radio frequency band guarantees a long range, even through walls and ceilings.

Programming via the display is quick and intuitive while its compact size means it can be easily installed in false ceilings (picture 1.2b) and interconnection boxes (picture 1.2c).

Picture 1.2a

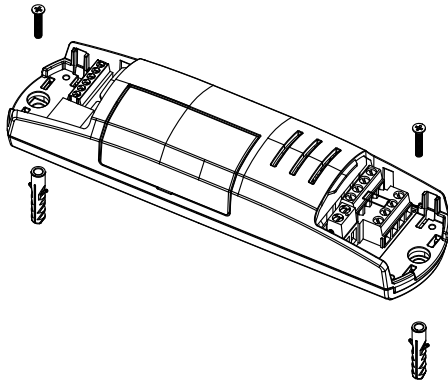

Picture 1.2b

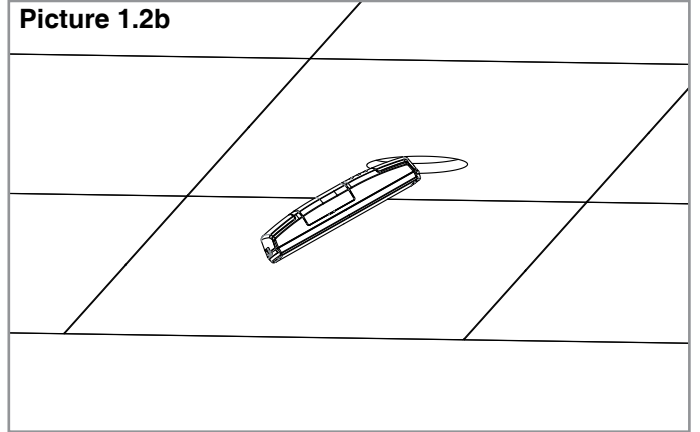

Picture 1.2c

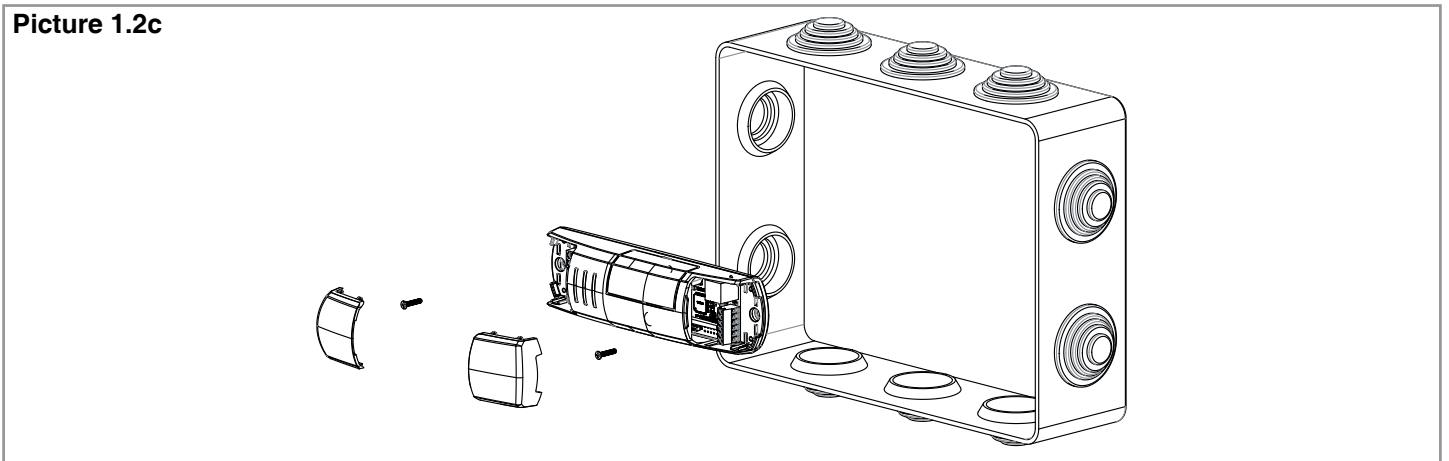

Picture 1.2d

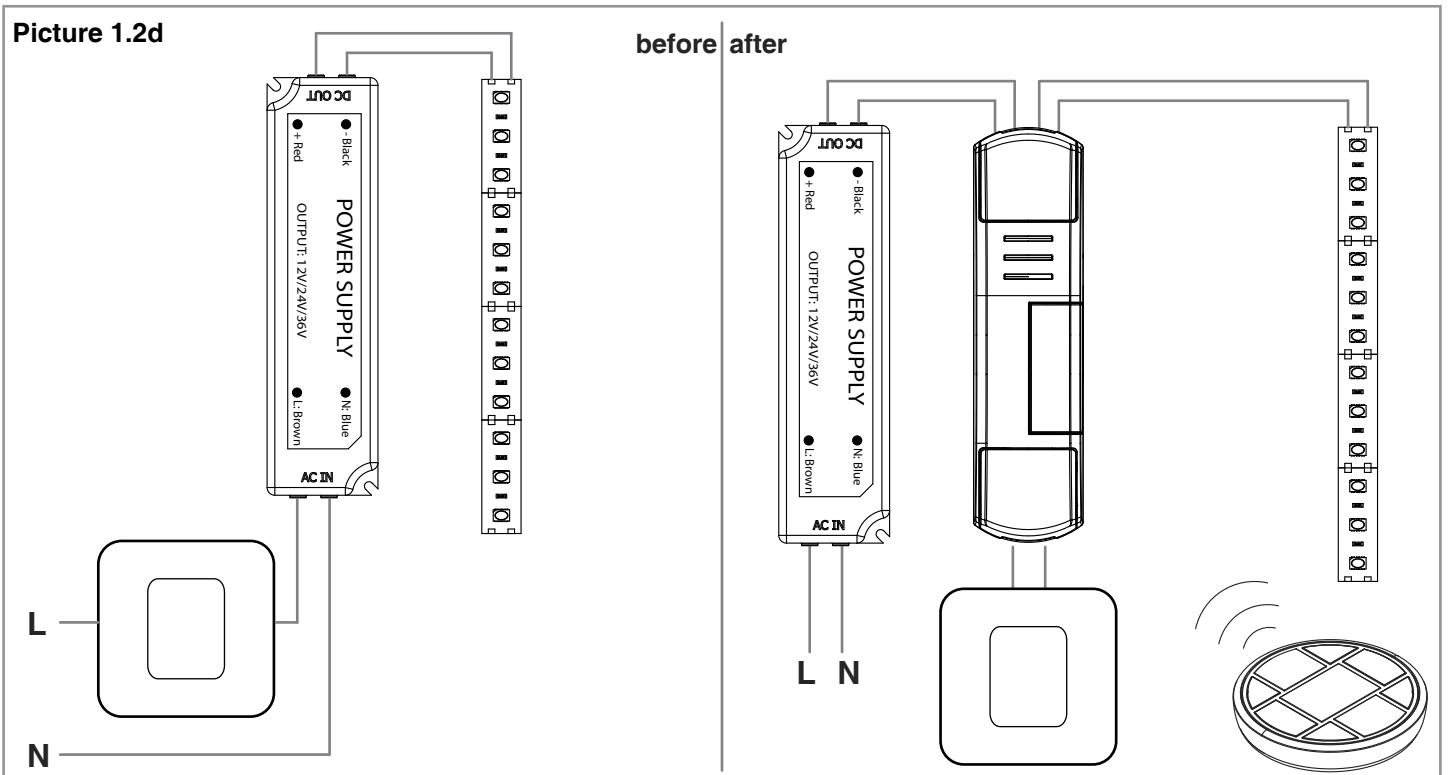

2 ELECTRICAL CONNECTIONS

2.1 CONNECTION DIAGRAM

Picture 2.1

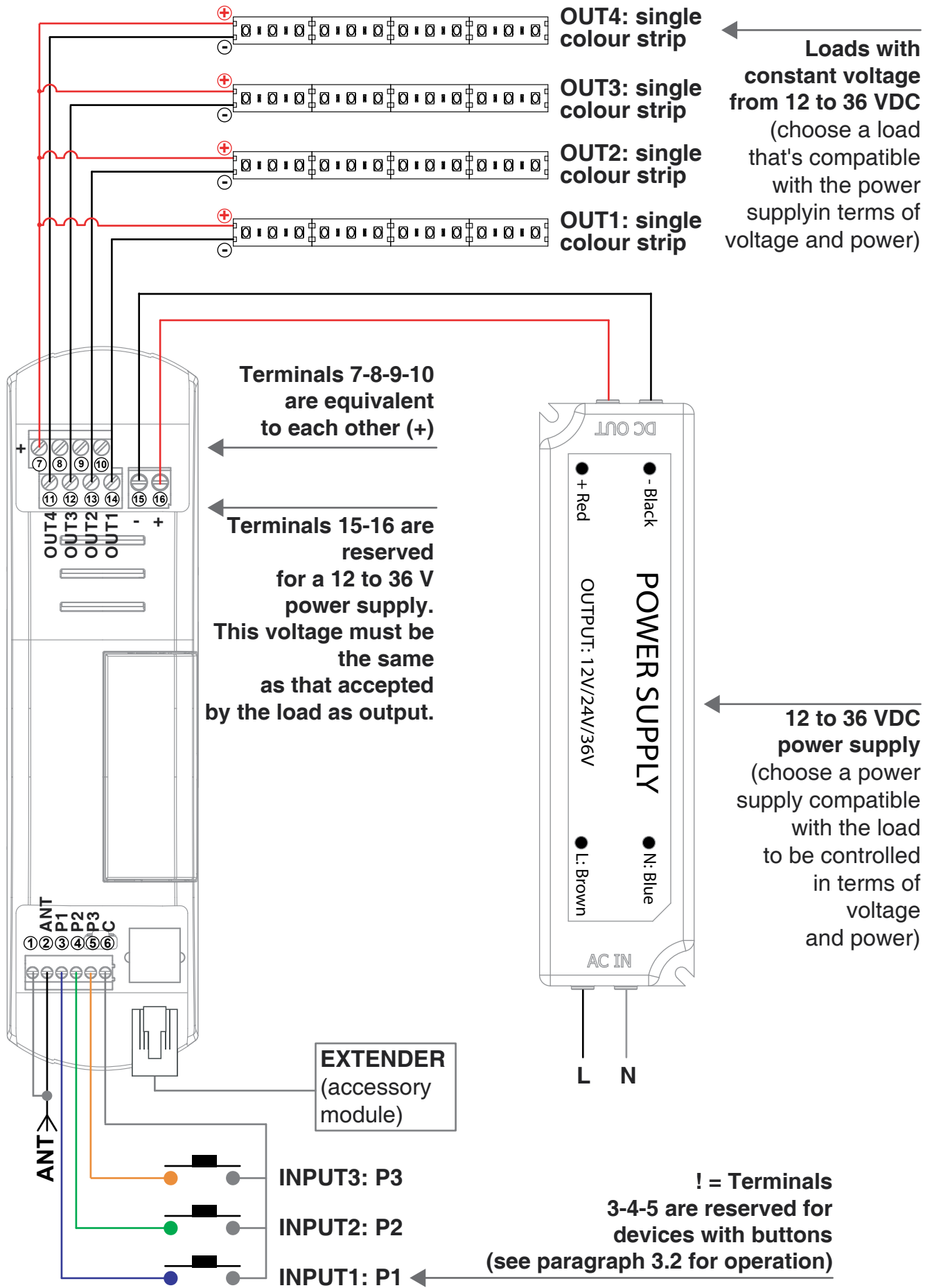

NOTE: multiple buttons or loads can be connected by using parallel cabling.

2.2 DESCRIPTION OF CONNECTIONS

- Not all loads and buttons need to be connected for the control unit to operate correctly.
- Use wires with a suitable cross-section for the load connected.
- Multiple buttons can be connected by using parallel cabling.
- Multiple buttons or loads can be connected by using parallel cabling.
- For ease of connection terminals 7-8-9 and 10 are equivalent to each other. The positive of each possible load can therefore be connected to a different terminal

WARNING: If a load with higher consumption than that allowed (see control unit information plate data) is connected, the control unit will go into safety mode, switching off the load for one minute.

TERMINAL	DESCRIPTION
1	Aerial sleeve
2	Aerial signal
3	Button P1 input
4	Button P2 input
5	Button P3 input
6	Common for buttons
7, 8, 9, 10	Output +24V
11	Output 4
12	Output 3
13	Output 2
14	Output 1
15	Power supply
16	Power supply + (12-24-36V)

3 USE OF THE CONTROL UNIT

3.1 USE VIA RADIO

To control the loads via radio you must have compatible transmitters and therefore must carry out the association procedure, see paragraph 4.1.

The transmitter's control modes depend on the transmitter model used.

If the transmitter is of a generic type, its operation depends on the way it is programmed (see paragraph 4.1, table 4.1d).

If the transmitter is multifunctional, refer to the transmitter manual, to the paragraph entitled "commands sent by the transmitter", bearing in mind that it is a "dimmer" device.

3.2 USE VIA WIRE

The device is set up to accept commands via wire by button in terminals 4, 5 and 6. Should you want to control the load only via radio, it is not necessary to connect these devices for the control unit to work properly.

The behaviour of the different keys is shown in the following table:

	LOAD OFF	LOAD ON
INPUT P1: short press	Load 1 on	Load 1 off
INPUT P1: long press	Dimmer intensity up of load 1	Dimmer intensity up / Dimmer intensity down of load 1.
INPUT P2: short press	Load 2 on	Load 2 off
INPUT P2: long press	Dimmer intensity up of load 2	Dimmer intensity up / Dimmer intensity down of load 2
INPUT P3: short press	Load 3 on	Load 3 off
INPUT P3: long press	Dimmer intensity up of load 3	Dimmer intensity up / Dimmer intensity down of load 3

WARNING: Load 4 can be controlled only by radio or if the inputs are set as synchronised (see paragraph 4.7).

WARNING: The behaviour of the inputs can be modified with the procedure shown in paragraph 4.7.

4 CONTROL UNIT SETTINGS

In the programming zone (see picture 4) you can access the programming menu using the keys and the display. Short presses on the "SET" key let you scroll through the different programmable functions visible on the display ("P1", "P2"...). Prolonged pressure on the "SET" key (approx. 3 seconds) allows access to the menu for the function selected.

The different types of programming available are:

- "P1": programming of radio
- "P2": deletion of radio
- "P3": activation/deactivation of memory of last value at switch-on
- "P4": selection of fade on
- "P5": selection of fade off
- "P6": selection of minimum intensity value
- "P7": choice of loads matched with wired commands (dedicated or synchronised)
- "P8": load state when the control unit is switched on
- "P9": timed on
- "FS": factory setting, reset control unit

After 60 seconds' inactivity (no keys pressed), the control unit goes into stand-by with the displays switched off.

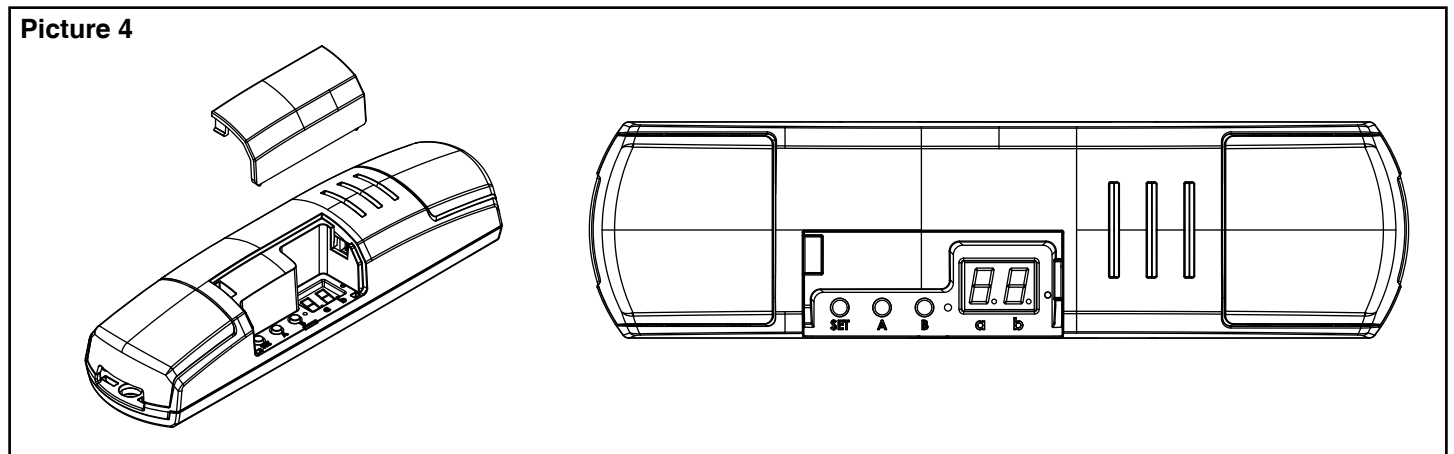

4.1 MENU "P1": RADIO PROGRAMMING

This procedure lets you programme compatible multifunctional or generic transmitters.

WHICH REMOTE CONTROL DO YOU WANT TO ASSOCIATE WITH THE CONTROL UNIT?

MULTIFUNCTIONAL TRANSMITTERS - MODELS AND CODES



CODE:
HB70-1L

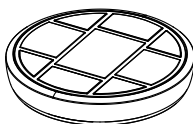

CODE:
HB80-30D,
HB80-2L
HB80-4L,
HB80-4RGBW,
HB80-30RGBW

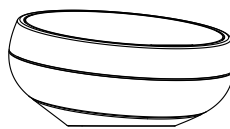

CODE:
HB90-6LT
HB90-6DM
HB90-8P

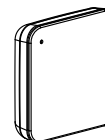

CODE:
TOUCH-1L
TOUCH-1
TOUCH-1CCT

With multifunctional transmitters the transmitter control modes depend on the model used. Refer to the transmitter manual, to the paragraph entitled "commands sent by the transmitter", bearing in mind that it is an "dimmer" device.

GENERIC TRANSMITTERS - MODELS AND CODES

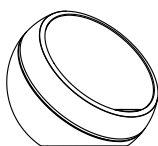

CODE:
HB70-5G

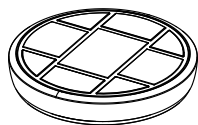

CODE:
HB80-6G



CODE:
MCU-TX4

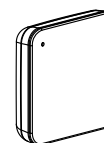

CODE:
TOUCH-1G
TOUCH-2G
TOUCH-4G

With generic transmitters, the transmitter's control modes depend on the function associated with the key during the association procedure.

The available function for the key are:

TABELLA 4.1 - KEY FUNCTIONS OF THE GENERIC TRANSMITTER

NUMBER TO BE SET IN "STEP 4b" OF THE PROCEDURE	KEY FUNCTION
2	ON/OFF
3	ON
4	OFF
5	Dimmer intensità UP
6	Dimmer intensità DOWN
7	Short press: ON/OFF Prolonged press: Dimmer intensità UP/ DOWN
8	Short press: ON Prolonged press: Dimmer intensità UP
9	Short press: OFF Prolonged press: Dimmer intensità DOWN
0	"Soft Off 1 hr": gradual fading in one hour (see paragraph 5.1)

PROCEDURE

STEP 1

Short presses on the "SET" key let you scroll through the menu until "P1" programming appears on the display.

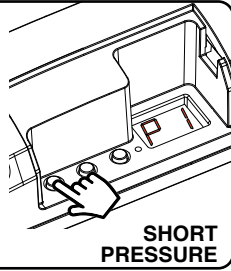

STEP 2

A prolonged press on the "SET" key (approx. 3 seconds) takes you into programming.

The LED on the receiver comes on

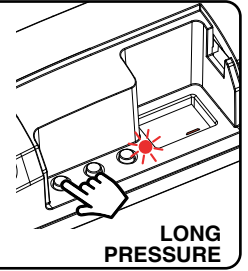

STEP 3

WHICH OUTPUT DO YOU WANT TO CONTROL?

Short presses on key "A" let you choose the output to programme the transmitter on, shown on display "a", see table alongside.

DISPLAY "a"	OUTPUT
1	OUT 1
2	OUT 2
3	OUT 3
4	OUT 4
A	ALL OUT

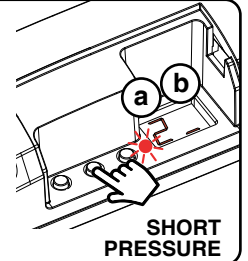

WHICH TRANSMITTER DO YOU WANT TO PROGRAMME?

MULTIFUNCTION TRANSMITTER

(see models and codes on previous page)

GENERIC TRANSMITTER

(see models and codes on previous page)

STEP 4a

Short presses on key "B" let you set value "1" on the display

(the display "a" shows the output to associate to the transmitter)

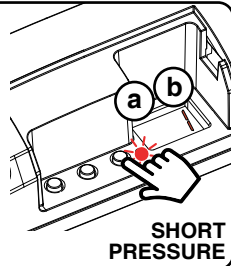

STEP 4b

Short presses on key "B" let you choose the function you want to programme shown on the displays. See table 4.1 on the previous page.

(the display "a" shows the output to associate to the transmitter)

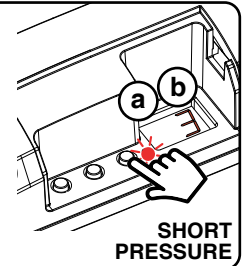

STEP 5

Give a long press on key "B" (approx. 3 seconds).

The LED on the display comes on

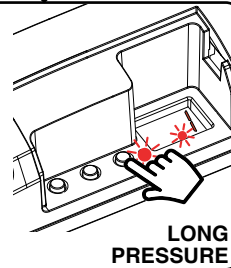

STEP 6

Make a transmission with the transmitter to be saved (see transmitter manual, the paragraph entitled "transmitter programming").

The LED on the receiver flashes 3 times to signal that it has been received.

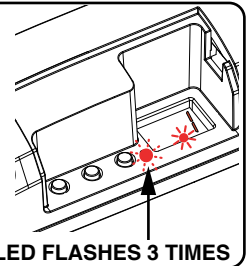

STEP 7

The control unit listens for 50 seconds in case you want to add other transmitters. To immediately exit the procedure give a short pressure on key "b".

The LED on the display turns off

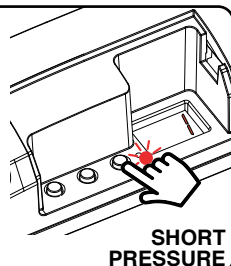

STEP 8

The control unit goes back to the menu displaying the radio programming. If you want to save other transmitters, go back to point 3 of this procedure.

If you want to go back to the menu displaying the different types of programming, give a prolonged press to the "SET" key (approx. 3 seconds).

4.2 MENU "P2": DELETION OF RADIO

These procedures let you delete transmitters that have already been programmed from the receiver's memory.

DELETION OF SINGLE TRANSMITTER CHANNEL:

STEP 1

Short presses on the "SET" key let you scroll through the menu until "P2" programming appears on the display.

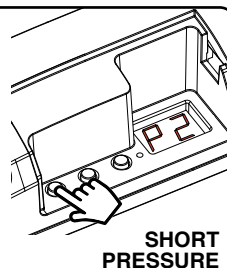

PASSO 2

A prolonged press on the "SET" key (approx. 3 seconds) takes you into programming.

The LED on the receiver lights up

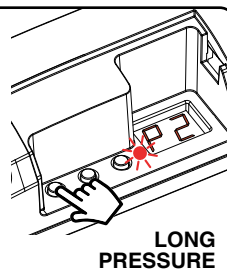

What is shown on display "a" and "b" has no influence on this procedure.

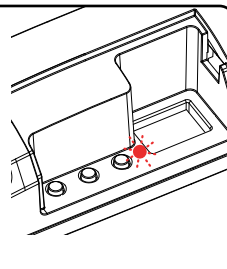

STEP 3

Give a long press on key "B" (approx. 3 seconds)

The LED on the receiver starts to flash

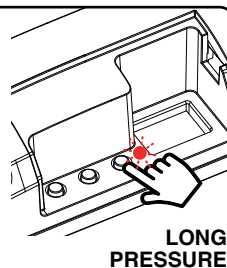

STEP 4

Within 5 seconds make a transmission with the remote control that you want to delete.

The LED on the receiver will flash rapidly and stay on

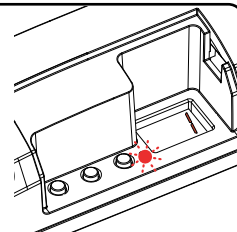
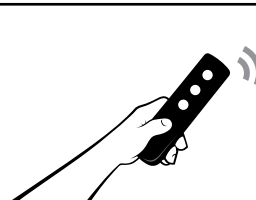

MAKE A TRANSMISSION WITH THE TRANSMITTER

STEP 5

The control unit goes back to the menu displaying the radio deletion. If you want to delete other transmitters, go back to point 3 of this procedure.

If you want to go back to the menu displaying the different types of programming, give a prolonged press to the "SET" key (approx. 3 seconds).

DELETION OF ALL TRANSMITTERS MATCHED WITH AN OUTPUT:

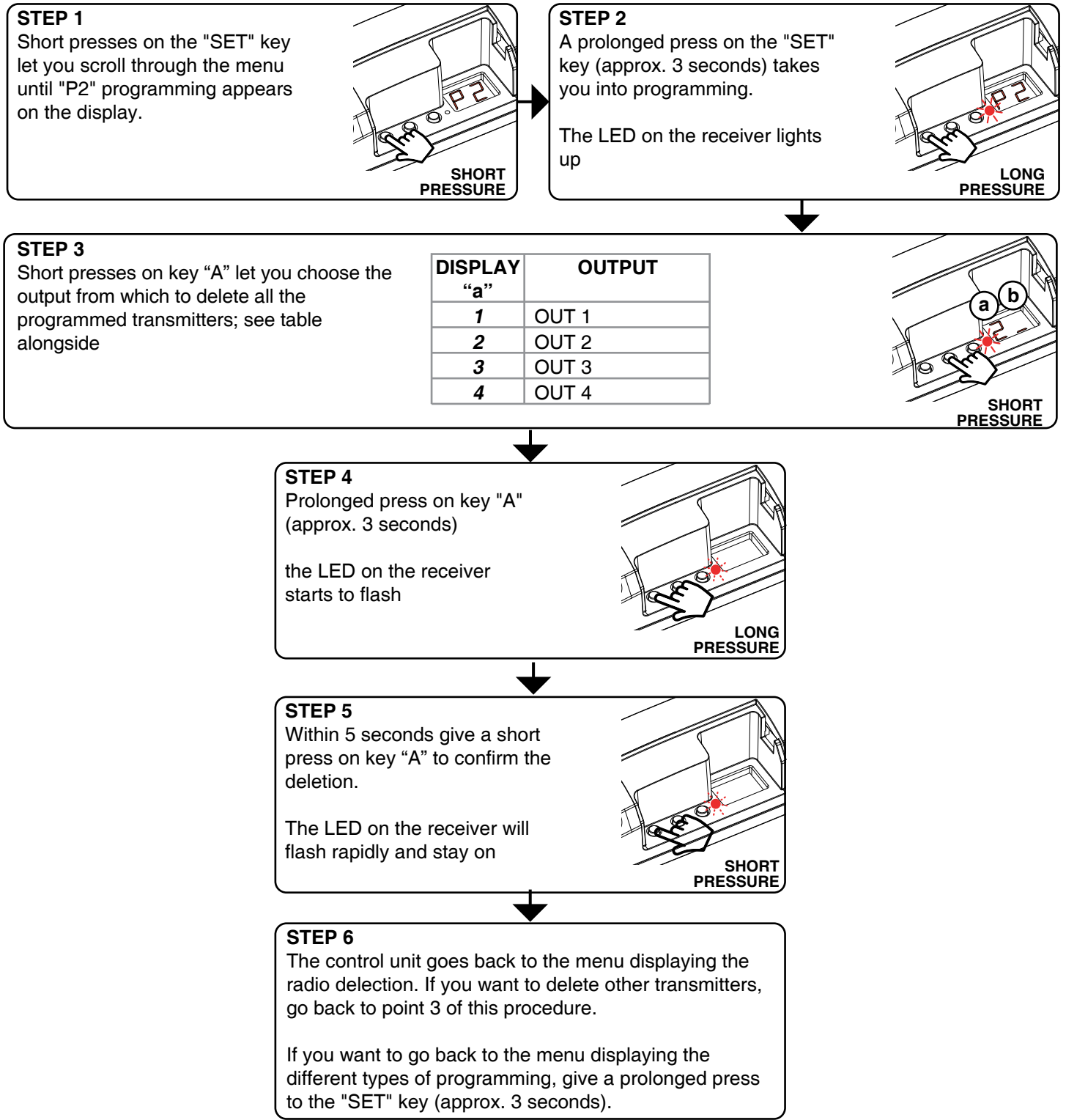

DELETION OF ALL THE SAVED TRANSMITTERS:

STEP 1

Short presses on the "SET" key let you scroll through the menu until "P2" programming appears on the display.

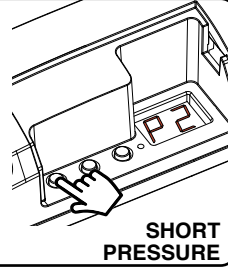

STEP 2

A prolonged press on the "SET" key (approx. 3 seconds) takes you into programming.

The LED on the receiver lights up

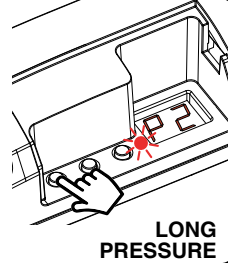

What is shown on display "a" and "b" has no influence on this procedure.

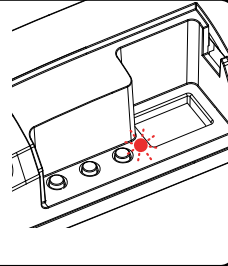

STEP 3

Give a long press on key "B" (approx. 3 seconds)

The LED on the receiver starts to flash

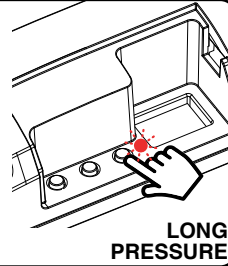

STEP 4

Within 5 seconds quickly press key "B" to confirm the deletion.

The LED on the receiver will flash and stay on

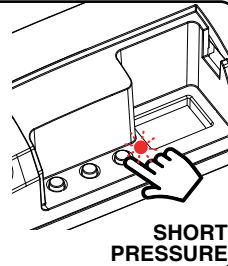

STEP 5

The control unit goes back to the menu displaying the radio deletion. If you want to delete other transmitters, go back to point 3 of this procedure.

If you want to go back to the menu displaying the different types of programming, give a prolonged press to the "SET" key (approx. 3 seconds).

4.3 MENU "P3": "SAVE" FUNCTION (BRIGHTNESS LEVEL AT SWITCH-ON)

Default: all the loads come on at maximum brightness

With this procedure you can set the intensity value at which the loads come on.
The setting will be effective for all the outputs.

PROCEDURE:

STEP 1

Short presses on the "SET" key let you scroll through the menu until "P3" programming appears on the display.

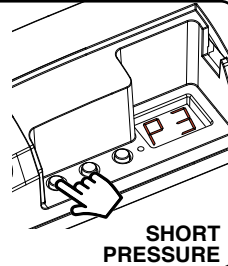

STEP 2

A prolonged press on the "SET" key (approx. 3 seconds) takes you into programming.

The LED on the receiver lights up

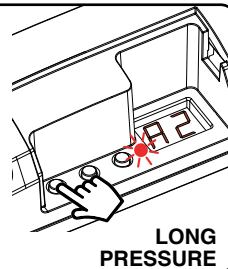

STEP 3

Display "a" always shows the letter "A" (all).

Make short presses on key "B" to choose the setting you want to set based on table alongside.

DISPLAY	SAVE FUNCTION: INTENSITY AT SWITCH-ON COMMAND
1	"SAVE" function on. The load will switch on at the last brightness value set before it was switched off
2	Switch-on of load at maximum intensity with white light

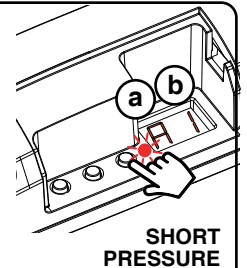

STEP 4

To confirm give a prolonged press on the "SET" key (approx. 3 seconds).

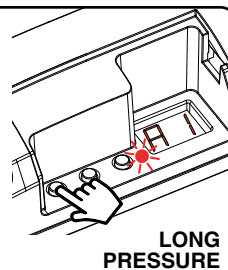

STEP 5

The control unit goes back to the menu displaying the different types of programming.

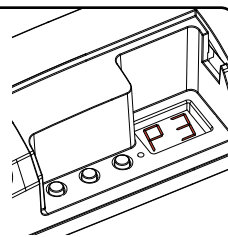

WARNING: the save function is activated/deactivated across all loads.

4.4 MENU "P4": FADE SETTING: GRADUAL SWITCH-ON

Default: switch-on in approx. 0.5

This procedure means you can set the duration of the switch-on time.

PROCEDURE:

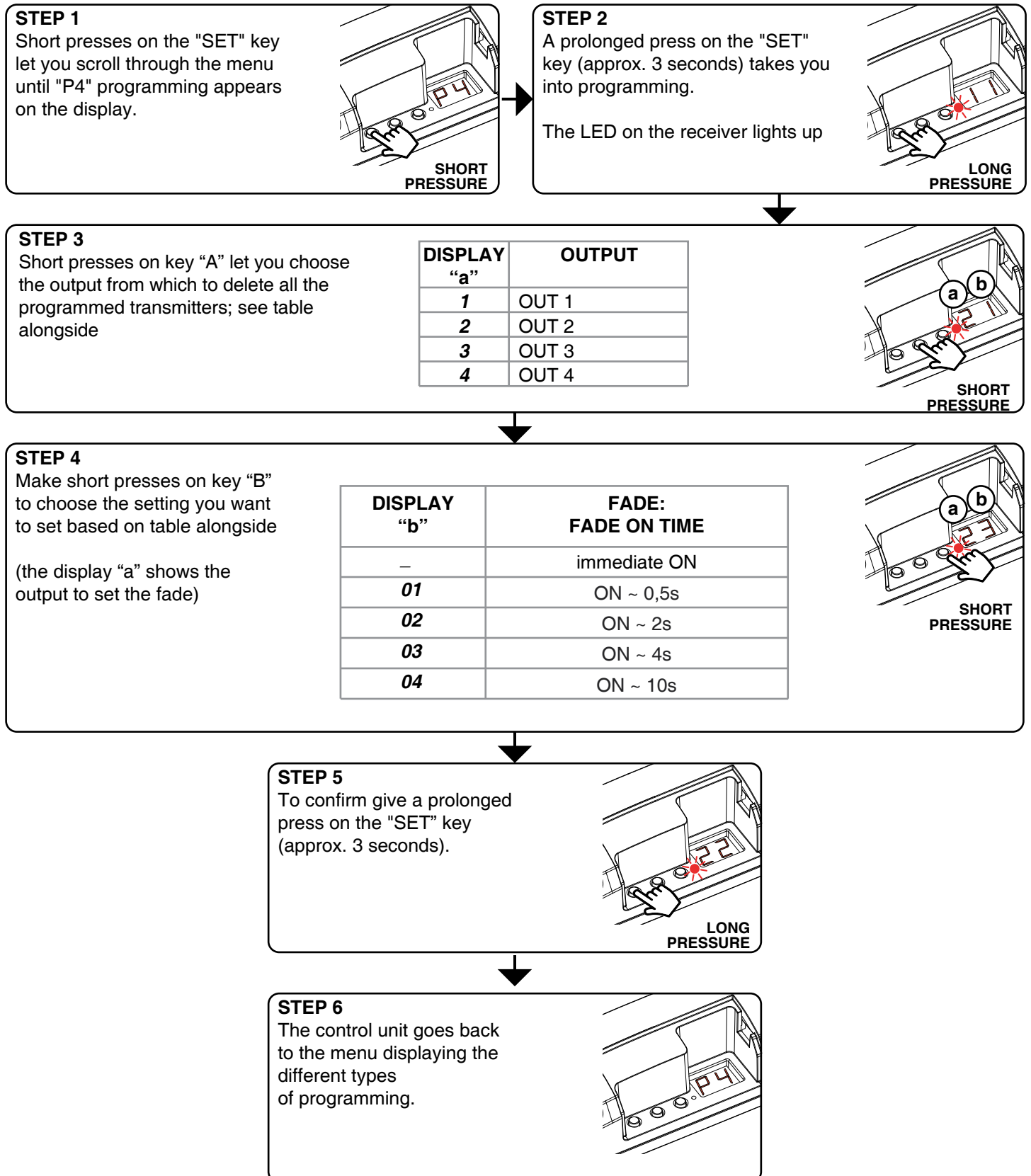

4.5 MENU "P5": FADE SETTING: GRADUAL SWITCH-OFF

Default: switch-off in approx. 0.5

This procedure means you can set the duration of the switch-off time.

PROCEDURE:

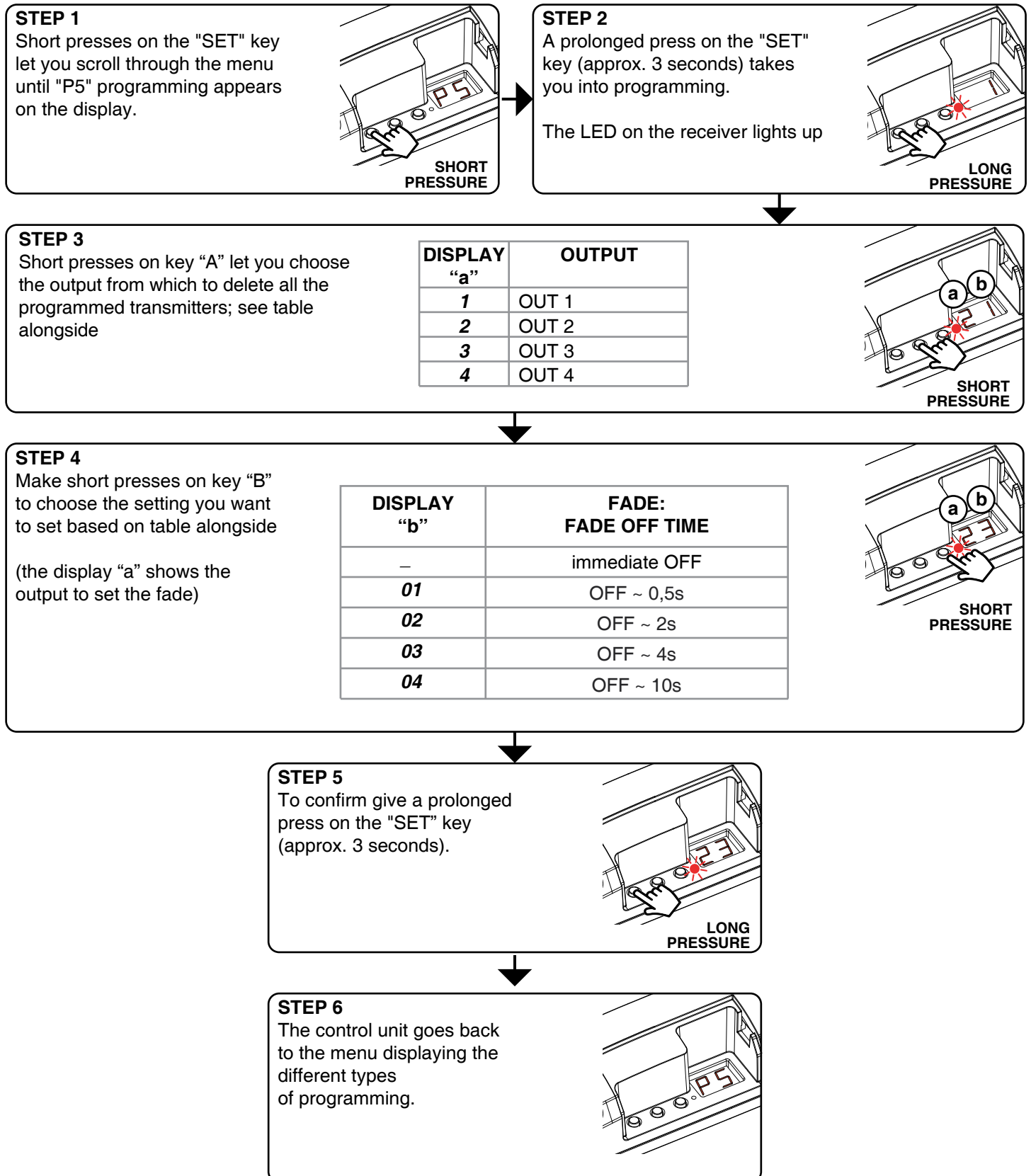

4.6 MENU "P6": SELECTION OF MINIMUM INTENSITY VALUE

Default: No minimum value

This procedure lets you select the minimum intensity value that can be set during normal operation.

PROCEDURE:

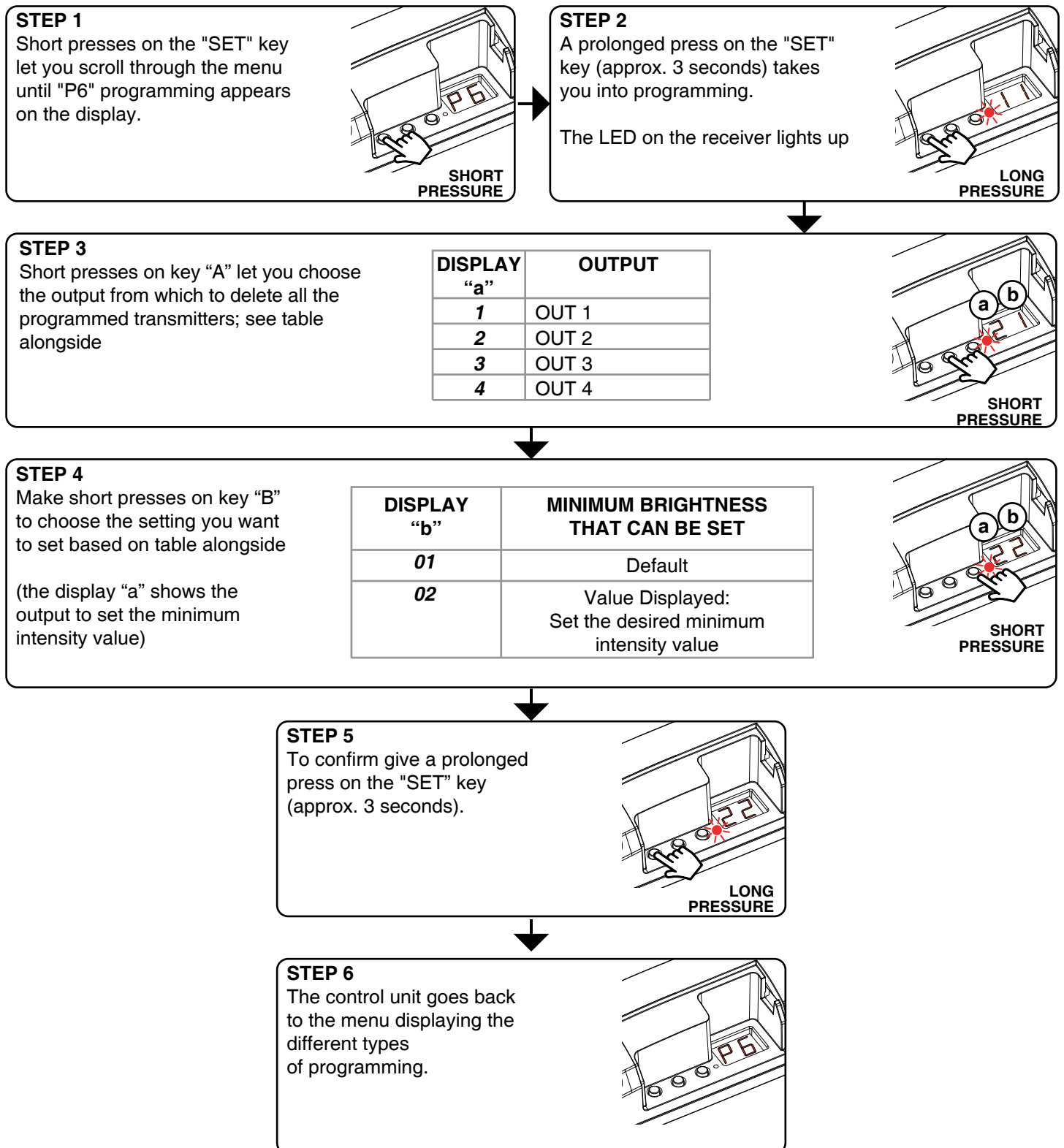

WARNING: The minimum brightness must be set on one load at a time.

If you want to set the minimum brightness on multiple loads, repeat the procedure from point 1.

4.7 MENU "P7": CHOICE OF LOADS MATCHED WITH WIRED CONTROLS

Default: loads controlled separately

This procedure lets you set which loads the wired controls act on, and how.

PROCEDURA:

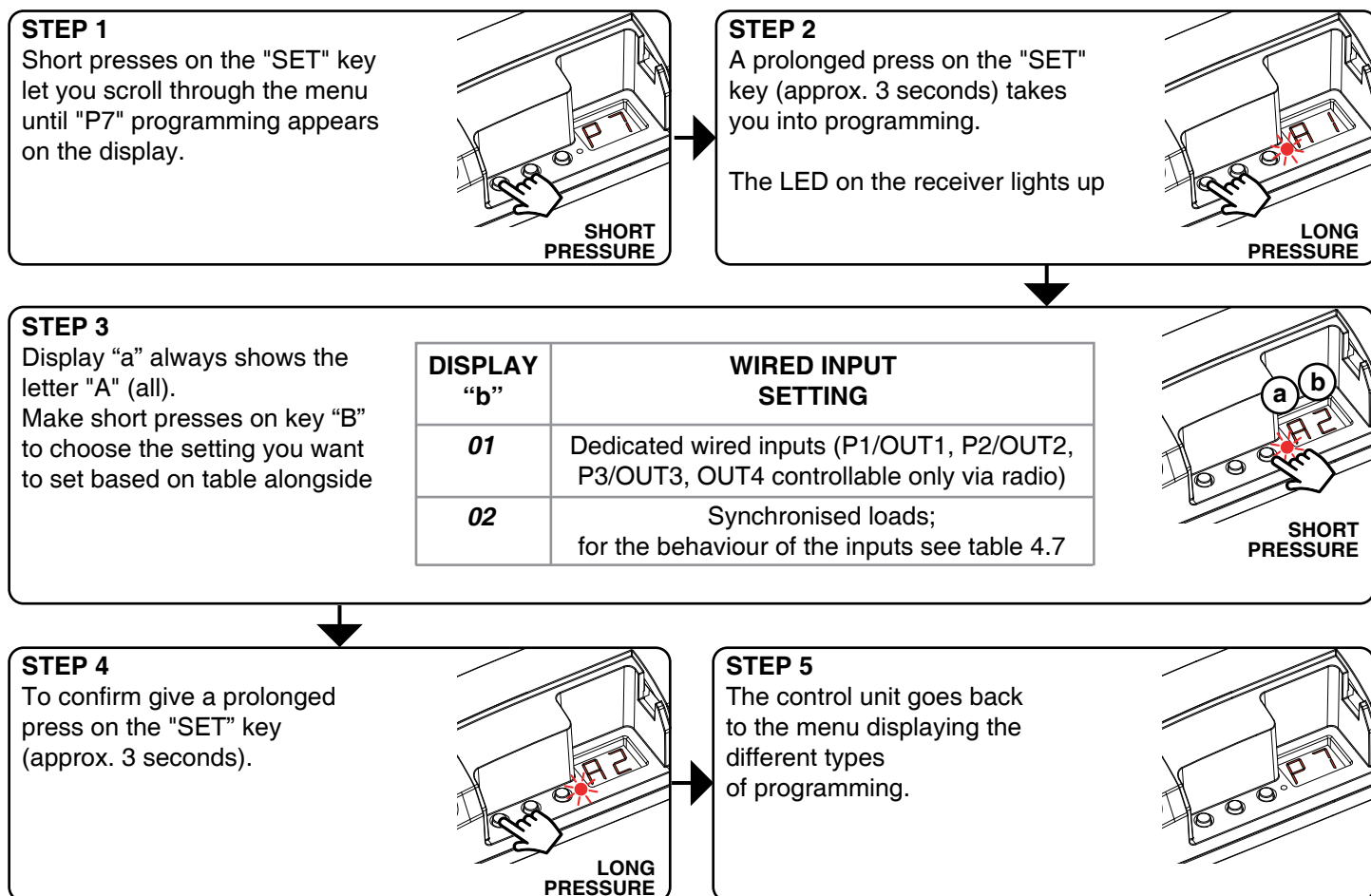

Tab. 4.7

	LOAD OFF	LOAD ON
INPUT P1: short press	Load 1, 2, 3 and 4 On	Load 1, 2, 3 and 4 Off
INPUT P1: long press	Dimmer intensity up of load 1, 2, 3 and 4	Dimmer intensity up / Dimmer intensity down of load 1, 2, 3 and 4
INPUT P2: short press	Load 1, 2, 3 and 4 On	No action
INPUT P2: long press	Dimmer intensity up of load 1, 2, 3 and 4	Dimmer intensity up of load 1, 2, 3 and 4
INPUT P3: short press	No action	Load 1, 2, 3 and 4 Off
INPUT P3: long press	No action	Dimmer intensity down of load 1, 2, 3 and 4

4.8 MENU "P8": LOAD STATE WHEN THE CONTROL UNIT IS SWITCHED ON

Default: Light Off

This process is used to set the state of Leds when the control unit is switched on (for example when the power supply is provided by a general switch or timer).

PROCEDURE:

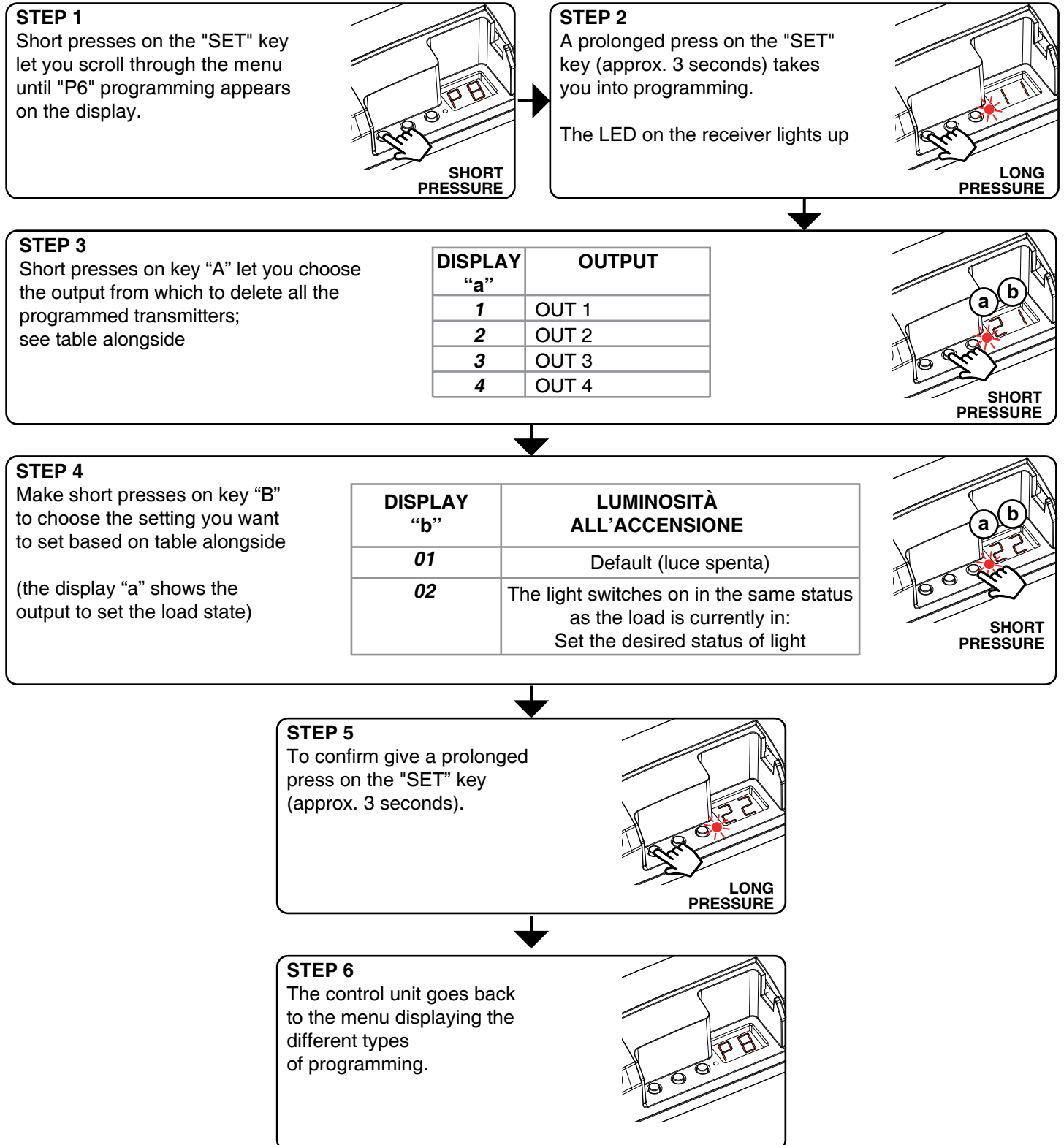

4.9 MENU "P9": TIMED ON

Default: No timing

This process is used to set the time for which the Leds stays on before an automatic switch off.

PROCEDURE:

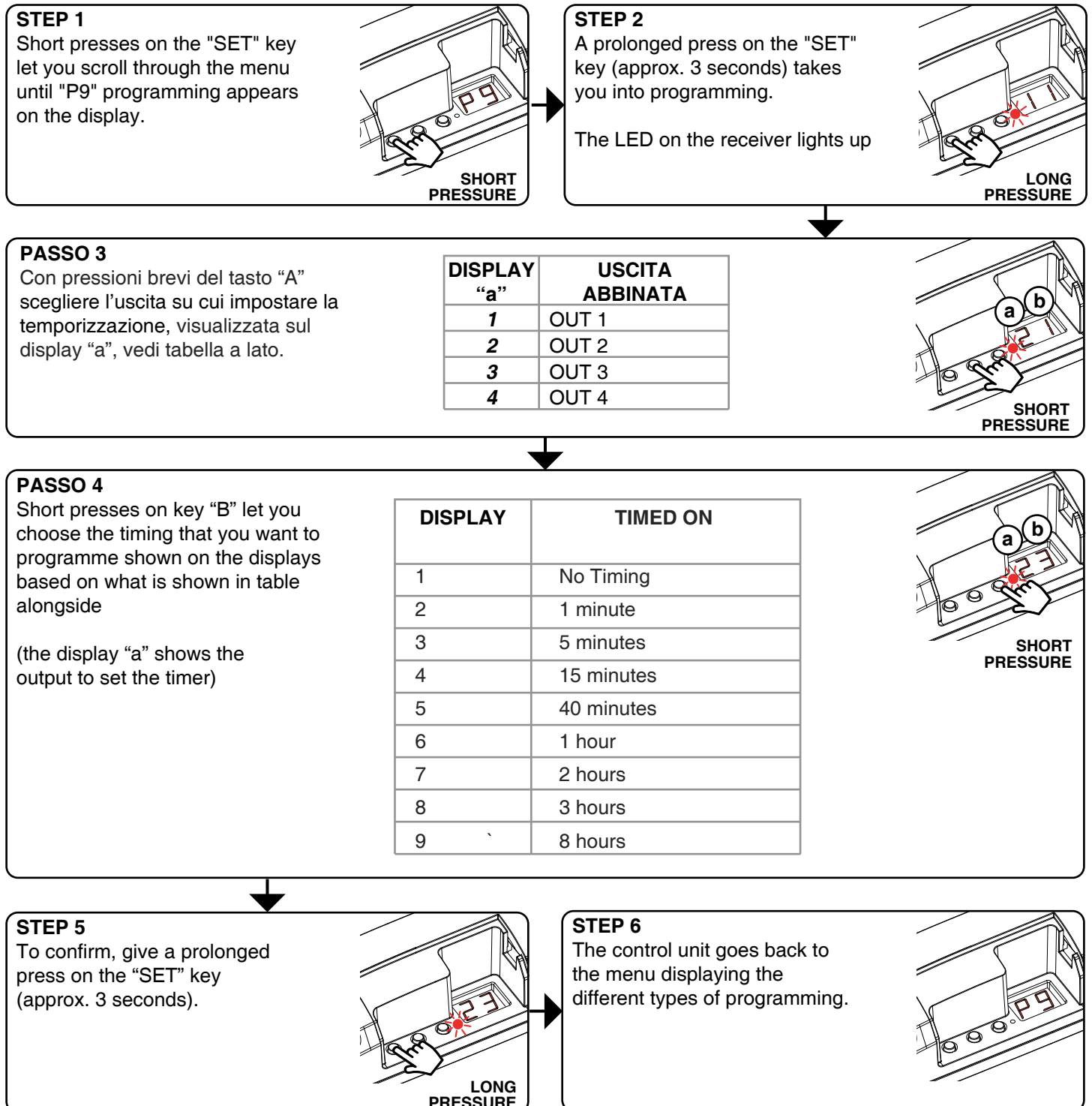

4.10 MENU "FS": FACTORY SETTING, RESET DELLA CENTRALE

This procedure let you take the control unit back to factory settings.

PROCEDURE:

STEP 1
Short presses on the "SET" key let you scroll through the menu until "FS" programming appears on the display.

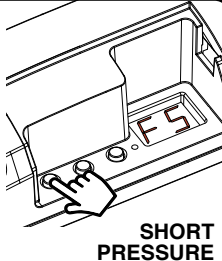

SHORT PRESSURE

STEP 2
A prolonged press on the "SET" key (approx. 3 seconds) takes you into programming.
The LED on the receiver lights up

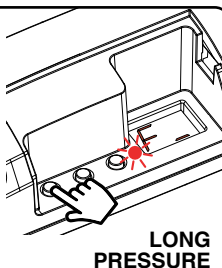

LONG PRESSURE

STEP 3
Con pressioni brevi del tasto "B" posso modificare l'impostazione visualizzata sul display "b":

display = F1	reset factory parameters, but no deletion of already programmed transmitters
display = F2	full reset of factory parameters, even stored transmitters will be deleted

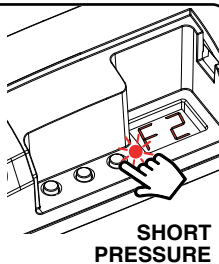

SHORT PRESSURE

STEP 4
To confirm, give a prolonged press on the "SET" key (approx. 3 seconds).
The LED flashes

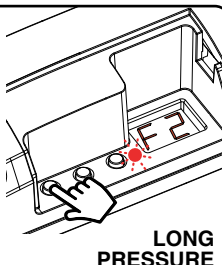

LONG PRESSURE

STEP 5
The control unit goes back to the menu displaying the different types of programming.

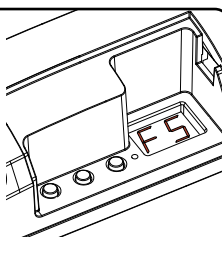

5 FURTHER DETAILS

The following paragraphs describe the ways colour is controlled.

5.1 “SOFT OFF 1 HR” FUNCTION: FADE OFF

The "Soft off 1 hr" function is a gradual fading off in one hour starting from the colour and intensity set at the time the command was sent.

This function can be activated after adjusting the intensity as desired (via radio or wire);

- VIA RADIO WITH GENERIC TRANSMITTER: with a generic transmitter (see paragraph 4) programmed with the “soft off 1 hr” function (see table 4.1).

This gradual switch-off can be interrupted at any time by the sending of another command via radio or via wire.



MNLTOP-V8/4ENV1.1

Nexta Tech

company brand of Team srl
via G.Oberdan 90, 33074
Fontanafredda (PN) - Italy
Ph. +39 0434 998682
Email: info@nexta-tech.com
Web: www.nexta-tech.com